

# Rimin Track Lights

ITEM SKU#: 662187490946

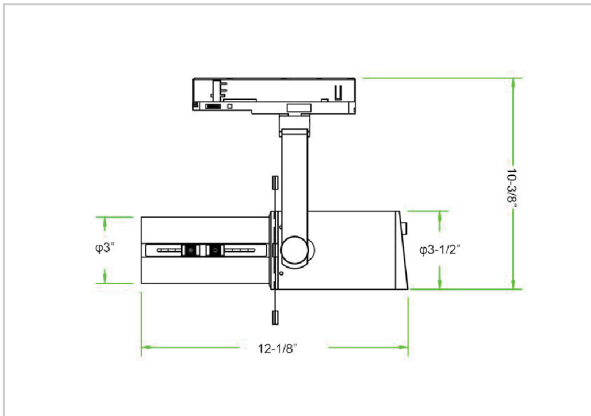

## Product Code : IK-RRIMINTL-20W-30K-WH-90C-ADB

Voltage	100 - 277 V AC, 50-60 Hz
Lumen Output	1470lm
Power	20W
Efficacy	140lm/w
CCT	3000K
CRI	>90
Beam Angle	60°
Light Distribution	Flood
LED Light Source	Osram SOLERIQ S 19
Start Time	Instant
Driver	Stand Alone (included)
Operating Position	Swiveling Type
Dimming	Triac Dimming, Local Dimming
Construction	Track
Mounting Type	Track Light Structure
Heads	Single Head
Finish	White
Height	10-3/8"
Diameter	3"
Width (W)	12-1/8"
Application Area	Indoor Applications

### Shapes (Narrow, Wide, Round, Square, and Other Shapes)

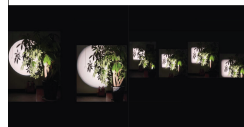

Rimin Projector Light is a versatile lighting solution designed for adaptability, aesthetics, and dynamic projection capabilities. It is 15° to 60° adjustable, which empowers you with tailored, precise illumination. In addition, the projection can be done in various shapes, such as round and square, allowing you to effortlessly create captivating visual displays.



## Technical Data

[Installation Instructions Link](#) ↓