

Nova Down Lights

ITEM SKU#: 662187496597

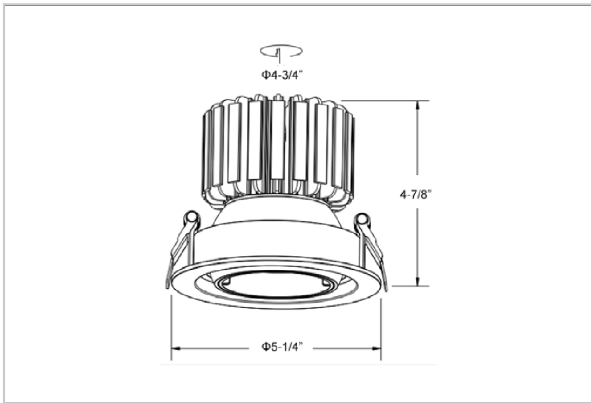

Product Code : IK-RNOVADL-30W-30K-WH-90C-15D

Voltage	100 - 277 V AC, 50-60 Hz
Lumen Output	2700lm
Power	30W
Efficacy	90lm/w
CCT	3000K
CRI	>90
Beam Angle	15°
Light Distribution	Spot
LED Light Source	Osram SOLERIQ S 19
Start Time	Instant
Driver	Stand Alone (included)
Operating Position	Swiveling Type, 360D
Dimming	On-Off / Triac / 0-10 V
Construction	Round
Mounting Type	Recessed
Heads	Single Head
Body Material	Aluminium Die cast
Finish	White
Height	4-7/8"
Diameter	5-1/4"
Cut Out	4-3/4"
Optics	Darklight Technology Black, Silver
Application Area	Guest Room, Corridor, Restaurant, Meeting Room Club, Hall, Hotel Entrance



Beam Spread (Options)

Spot 15°		Medium 24°		Flood 36°	
ft	Ø	ft	Ø	ft	Ø
3.0	0.72	3.0	1.41	3.0	2.03
9.0	2.15	9.0	4.22	9.0	6.09
15.0	3.58	15.0	7.04	15.0	10.15

Nova, a round shaped LED downlight made of aluminum die cast with high quality powder coated luminaire housing and optimum heat sink. The specular darklight reflector in this store light allows outstanding visual comfort to the visitors so that they are able to explore the merchandise at ease.