



Giving Your Store The Extra Oomph!

Store
Lights



Product Catalog
2022-23

Store
Lights

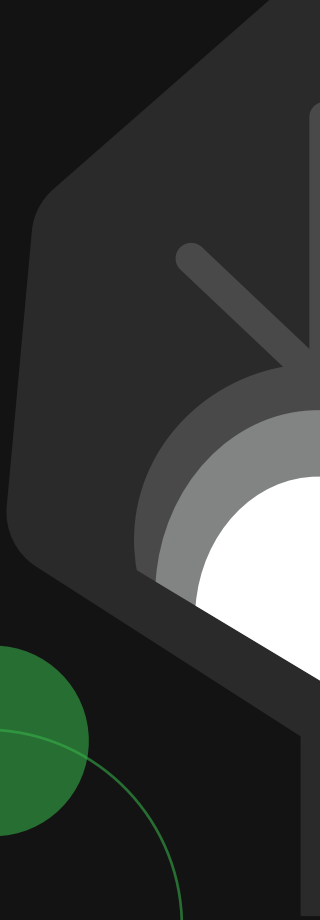

INDEX

Retail Revolution:
How Times Have Changed? **03-04**

Lighting: Why is it at Key Element
in Store Construction & Planning? **05-06**

Some Other Ways in Which
Lighting can Impact Your Business **07**

IKIO, Making Your Vision of
Store Lighting Come True! **08**

How Do We Make Store
Lighting Super Accessible? **09-10**

Track Lights **11-12**

Alem **13**



Prime **14**



Optik **15**



Bolide **16**



Ork **17**



Rimin **18**







Trang **19**

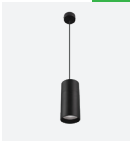

Downlights 20-21

Lumos 22	Theia 23	Olivio 24	Glint 25	Ocul 26	Nova 27	Scint 28
						
Odin 29	Glim 30	Flare 31	Gleam 32	Aspro 33		
						

Pendant Lights 34-35

Remus 36	Aurora 37	Eos 38	Mica 39	Flaxo 40
				

Cross Reference Guide **41-42**

Know More About IKIO **43**





Retail Revolution: How Times Have Changed?

While the internet has made shopping more convenient for us, many people still don't prefer buying merchandise without touching, smelling, or experiencing it firsthand.

In fact, according to a recent survey that includes over 1,000 U.S. consumers, it is found that most millennials like to visit brick-and-mortar retail stores far more than their online counterparts. To be more specific, half of the millennials (about 56%) surveyed accepted to have regularly shopped in physical stores at least once a week. Their reason seemed to vary for this — from the benefit of avoiding delivery fees to the convenience of immediate possession of the item to the interactive experience of trying or seeing a product in person.

That's why it is crucial for store owners to ramp up their commercial space, as it can highly influence their brand perception and help them gain more customers in the long run.



Lighting: Why is it a Key Element in Store Construction & Planning?

While lighting during a store's construction & planning process is often given the least amount of importance, it, in fact, contributes majorly in setting the mood and influencing people's buying decisions. Studies over the years have proved that quality lighting in stores also boosts the overall sales of a business.

To better understand this, let's have a look at what Gerry Weber did!



Gerry Weber, a German fashion retailer, installed high-end retail lights in his store to highlight his key merchandise. He realized that the targeted customers felt comparatively more comfortable and spent more time exploring the merchandise. This boosted the sales of his business by an average of 10%.

Some Other Ways in Which Lighting Can Impact Your Business



Target Group Appropriate Lighting

The change in intensity, color, color temperature, contrast, and uniformity of store lights has the ability to grab the attention of your target audience and influence their buying decision.



Revealing Authenticity

Quality lighting in a store with an excellent color rendering index and special light spectrums has the ability to reveal the true color and quality of the merchandise.



Adding an Element of Design to the Ceilings

Smart lighting solutions with elegant designs also contribute to enhancing the overall aesthetics of the stores. The extremely large ceiling areas in the retail outlets can be made more presentable with well-designed and exquisite store lights.



Soft Illumination

The modern LED store lights are virtually free from all sorts of harmful emissions, such as infrared radiation or UV radiation that can deteriorate the quality of your merchandise.

IKIO, Making Your Vision of Store Lighting Come True!

IKIO's ability to tune into customers' unique needs and deliver industry-forward solutions is what makes us stand out from other brands. We value every client's vision and therefore, offer custom-made solutions that perfectly align with it.

Disrupting Limitations in Store Lighting Through **Customized LED Solutions**

Other Brands

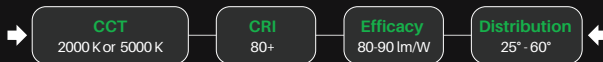

Bound By Limitations

V/S

IKIO

No Limitations: **We Customize Everything!**

IKIO offers the best in everything based on your requirements.

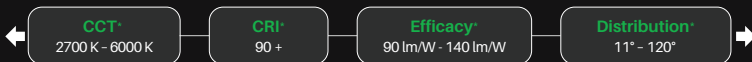

*Note: All of these can be customized as per your needs.







How Do We Make Store Lighting Super Accessible?

- We source all our components — LEDs, drivers, optics — only from the best vendors.
- We have high-end technology such as Goniometer, helping us deliver solutions without delays.
- We offer thorough assistance with the lighting layout so you can make the best of our solutions.
- We continuously innovate to develop solutions — such as our MARVELA SERIES — that bring down the hassle of complete fixture overhauls in stores.
- We are US-based, executing nationwide deliveries in a quick and efficient manner.

Track Lights

Track Lights, also called Accent Lights, add drama to a space by creating visual interest. Whether it is a small convenience store or a large department store, IKIO's track lights can be arranged in any space irrespective of the size. They can either be used as spot lights to highlight only a certain section of your store or they can be used to evenly illuminate the whole store.

-  Can be surface-mounted, recessed, or suspended.
-  Are highly customizable, low maintenance, and flexible.
-  Allow you to create the desired visual effect.



Alem

Track Light

Alem is a technologically advanced LED track light with incorporated electronic gear and chip on board. It also has a high-quality reflector with four different beam spreads. Moreover, the lamp housing of die-cast aluminum for optimal cooling allows the fixture to last longer than its traditional counterparts.



> Technical Parameters

Voltage	100 - 270 V AC, 50-60 Hz
Light Source	Bridgelux V13
Operating Position	Swiveling Type
Start Time	Instant
Driver	IK-LKAD029DC-05242
Beam Spread	Spot, Medium, Flood, Wide Flood
Dimming	0-10 V

CRI	Power (W)	CCT (K)	Total Lumen Output (lm)	Finish
>90	20 / 30	2700	1736 / 2604	Black / White
>90	20 / 30	3000	1822 / 2733	Black / White
>90	20 / 30	4000	1914 / 2870	Black / White
>90	20 / 30	5000	2009 / 3014	Black / White

Note: Product available in other Kelvin temperatures on request.

> Model/Colors

Available in Black and White.



> Application Areas

Track Light for Indoor Applications.



> Technical Drawing

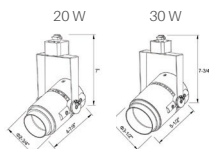

> Beam Spread (Options)

Spot	15°		Medium 24°		Flood 38°		Wide Flood 60°	
	ft	ø	ft	ø	ft	ø	ft	ø
3.0	0.72	3.0	1.41	3.0	2.03	3.0	3.15	
9.0	2.15	9.0	4.22	9.0	6.09	9.0	9.45	
15.0	3.58	15.0	7.04	15.0	10.15	15.0	15.75	

Note: Product available in other Kelvin temperatures on request.

Prime

Track Light

Prime is a technologically advanced LED track light with incorporated electronic gear and chip on board. It also has a high-quality reflector with three different beam spreads. Moreover, the lamp housing of die-cast aluminum for optimal cooling allows the fixture to last longer than its traditional counterparts.

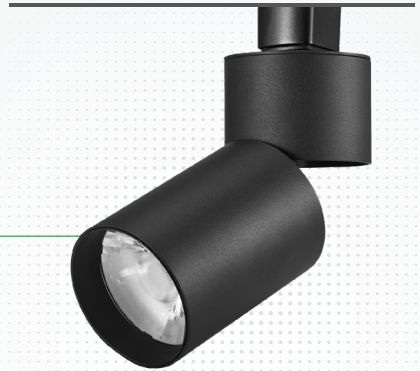

> Technical Parameters

Voltage	100 - 277 V AC, 50-60 Hz
Light Source	Osram SOLERIQ S 19
Operating Position	Swiveling Type
Start Time	Instant
Driver	Stand Alone (Included)
Beam Spread	Spot, Medium, Flood
Dimming	Triac Dimming

CRI	Power (W)	CCT (K)	Total Lumen Output (lm)	Finish
>90	20	2700	1733	Black / White
>90	20	3000	1819	Black / White
>90	20	4000	1911	Black / White
>90	20	5000	2006	Black / White

Note: Product available in other Kelvin temperatures on request.

> Model/Colors

Available in Black and White.



> Application Areas

Track Light for Indoor Applications.



> Technical Drawing

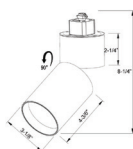

> Beam Spread (Options)

Spot		Medium		Flood	
11°		24°		38°	
ft	ø	ft	ø	ft	ø
3.0	0.72	3.0	1.41	3.0	2.03
9.0	2.15	9.0	4.22	9.0	6.09
15.0	3.58	15.0	7.04	15.0	10.15

Note: Product available in other Kelvin temperatures on request.

Optik

Track Light

Optik is a technologically advanced LED track light with incorporated electronic gear and chip on board. It also has a high-quality reflector with multiple beam spreads. Moreover, the lamp housing of die-cast aluminum for optimal cooling allows the fixture to last longer than its traditional counterparts.

› Technical Parameters

Voltage	100 - 277 V AC, 50-60 Hz
Light Source	Osram SOLERIQ S 19
Operating Position	Swiveling Type
Start Time	Instant
Driver	Stand Alone (Included)
Beam Spread	Spot, Medium, Flood, Wide Flood (Adjustable)
Dimming	Triac Dimming



CRI	Power (W)	CCT (K)	Total Lumen Output (lm)	Finish
>90	15 / 20 / 30	2700	1300 / 1744 / 2603	Black / White
>90	15 / 20 / 30	3000	1365 / 1831 / 2733	Black / White
>90	15 / 20 / 30	3500	1433 / 1923 / 2870	Black / White
>90	15 / 20 / 30	4000	1504 / 2019 / 3014	Black / White

Note: Product available in other Kelvin temperatures on request.

› Model/Colors

Available in Black and White.



› Application Areas

Track Light for Indoor Applications.



› Technical Drawing

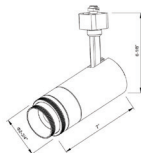

› Beam Spread (Adjustable)

Spot		Medium		Flood		Wide Flood	
11°		24°		36°		60°	
ft	o	ft	o	ft	o	ft	o
3.0	0.72	3.0	1.41	3.0	2.03	3.0	3.15
9.0	2.15	9.0	4.22	9.0	6.09	9.0	9.45
15.0	3.58	15.0	7.04	15.0	10.15	15.0	15.75

Note: 1. Product available in other Kelvin temperatures on request.
2. Ra>97 can be made at extra cost.

Bolide

Track Light

Bolide is a technologically advanced LED track light with incorporated electronic gear and chip on board. It also has a high-quality reflector with different beam spreads. Moreover, the lamp housing of die-cast aluminum for optimal cooling allows the fixture to last longer than its traditional counterparts.



> Technical Parameters

Voltage	100 - 277 V AC, 50-60 Hz
Light Source	Osram SOLERIQ S 19
Operating Position	Swiveling Type
Start Time	Instant
Driver	Stand Alone (Included)
Beam Spread	Spot, Medium, Flood, Wide Flood (Options)
Dimming	Triac Dimming

CRI	Power (W)	CCT (K)	Total Lumen Output (lm)	Finish
>90	30	2700	2603	Black / White
>90	30	3000	2733	Black / White
>90	30	3500	2870	Black / White
>90	30	4000	3013	Black / White

Note: Product available in other Kelvin temperatures on request.

> Model/Colors

Available in Black and White.



> Application Areas

Track Light for Indoor Applications.
Looks Small and Elegant. More Suitable for Ladies & Kids' Clothes Shops.



Note: Product available in other Kelvin temperatures on request.

> Technical Drawing

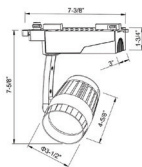

> Beam Spread (Options)

Spot	Medium	Flood	Wide Flood
15°	24°	36°	60°
ft 0	ft 0	ft 0	ft 0
3.0 0.72	3.0 1.41	3.0 2.03	3.0 3.15
9.0 2.15	9.0 4.22	9.0 6.09	9.0 9.45
15.0 3.58	15.0 7.04	15.0 10.15	15.0 15.75

Ork

Track Light

Ork is a technologically advanced LED track light with incorporated electronic gear and chip on board. It also has a high-quality reflector with different beam spreads. Moreover, the lamp housing of die-cast aluminum for optimal cooling allows the fixture to last longer than its traditional counterparts.



› Technical Parameters

Voltage	100 - 277 V AC, 50-60 Hz
Light Source	Osram SOLERIQ S 19
Operating Position	Swiveling Type
Start Time	Instant
Driver	Stand Alone (Included)
Beam Spread	Spot, Medium, Flood, Wide Flood (Adjustable)
Dimming	Triac Dimming

CRI	Power (W)	CCT (K)	Total Lumen Output (lm)	Finish
>90	20 / 30	2700	3013 / 2603	Black / White
>90	20 / 30	3000	1822 / 2733	Black / White
>90	20 / 30	3500	1913 / 2870	Black / White
>90	20 / 30	4000	2009 / 3013	Black / White

Note: Product available in other Kelvin temperatures on request.

› Model/Colors

Available in Black and White.



› Application Areas

Track Light for Indoor Applications.



› Technical Drawing

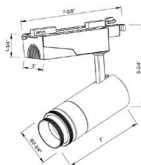

› Beam Spread (Adjustable)

Spot		Medium		Flood		Wide Flood	
15°		24°		36°		60°	
ft	ø	ft	ø	ft	ø	ft	ø
3.0	0.72	3.0	1.41	3.0	2.03	3.0	3.15
9.0	2.15	9.0	4.22	9.0	6.09	9.0	9.45
15.0	3.58	15.0	7.04	15.0	10.15	15.0	15.75

Note: 1. Product available in other Kelvin temperatures on request.
2. Ra>97 can be made at extra cost.

Rimin

Projector Light

Rimin Projector Light is a versatile lighting solution designed for adaptability, aesthetics, and dynamic projection capabilities. Its advanced features include an electronic gear, a chip on board, and a high-quality reflector that supports three different beam angles. It is 15° to 60° adjustable, which empowers you with tailored precise illumination. In addition, the projection options in various shapes, such as round, square, and more, allow you to effortlessly create captivating visual displays. Moreover, the lamp housing of die-cast aluminum for optimal cooling allows the fixture to last longer than its traditional counterparts. Experience the seamless fusion of functionality and aesthetics with Rimin Projector Light!

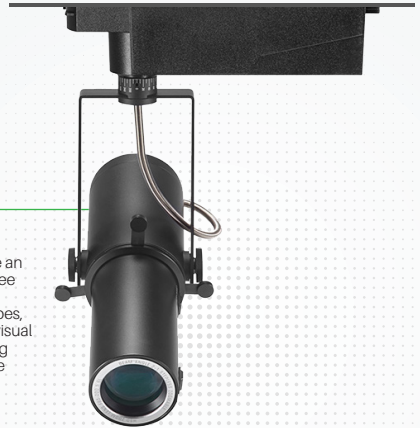

› Technical Parameters

Voltage	100 - 277 V AC, 50-60 Hz
Light Source	Osram SOLERIQ S 19
Operating Position	Swiveling Type
Start Time	Instant
Driver	Stand Alone (Included)
Shapes	Comes in Narrow, Wide, Round, Square, and Other Shapes
Dimming	Triac Dimming, Local Dimming

CRI	Power (W)	CCT (K)	Total Lumen Output (lm)	Finish
>90	20 / 30	2700	1400 / 2100	Black
>90	20 / 30	3000	1470 / 2205	Black
>90	20 / 30	3500	1544 / 2315	Black
>90	20 / 30	4000	1621 / 2431	Black

Note: Product available in other Kelvin temperatures on request.

› Model/Colors

Available in Black.



› Application Areas

Projector Light for Indoor Applications.



› Technical Drawing

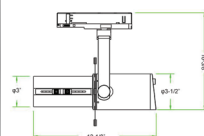

› Beam Spread / Shapes

15° to 60° (Adjustable)

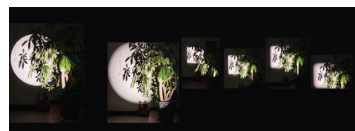

Note: 1. Product available in other Kelvin temperatures on request.
2. Ra>97 can be made at extra cost.

Trang

Track Light

Trang is a technologically advanced LED track light with incorporated electronic gear and chip on board. It also has a high-quality reflector with four different beam spreads. Moreover, the lamp housing of die-cast aluminum for optimal cooling allows the fixture to last longer than its traditional counterparts.



> Technical Parameters

Voltage	100 - 277 V AC, 50-60 Hz
Light Source	Osram SOLERIQ S 19
Operating Position	Swiveling Type
Start Time	Instant
Driver	Stand Alone (Included)
Beam Spread	Spot, Medium, Flood, Wide Flood
Dimming	Triac Dimming

CRI	Power (W)	CCT (K)	Total Lumen Output (lm)	Finish
>90	7 / 15 / 20 / 30	2700	541 / 1232 / 1627 / 2603 / 3294	Black / White
>90	7 / 15 / 20 / 30	3000	568 / 1294 / 1708 / 2733 / 3459	Black / White
>90	7 / 15 / 20 / 30	4000	596 / 1359 / 1793 / 2870 / 3632	Black / White
>90	7 / 15 / 20 / 30	5000	626 / 1427 / 1883 / 3013 / 3813	Black / White

Note: Product available in other Kelvin temperatures on request.

> Model/Colors

Available in Black and White.



> Application Areas

Track Light for Indoor Applications.



> Technical Drawing

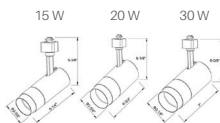



> Beam Spread (Options)

Spot		Medium		Flood		Wide Flood	
15°		24°		38°		60°	
ft	o	ft	o	ft	o	ft	o
3.0	0.72	3.0	1.41	3.0	2.03	3.0	3.15
9.0	2.15	9.0	4.22	9.0	6.09	9.0	9.45
15.0	3.58	15.0	7.04	15.0	10.15	15.0	15.75

Note: Product available in other Kelvin temperatures on request.

Downlights

Downlights, also called Ambient Lights, help in the overall illumination of a space. Their main function is to illuminate the space to a comfortable level of brightness. These lights cater to almost all kinds of retail spaces and sometimes even commercial spaces.

-  They are installed into a hollow opening in the ceiling.
-  The color temperature of a downlight helps set the ambience.
-  They barely take any vertical space in the place of installation.

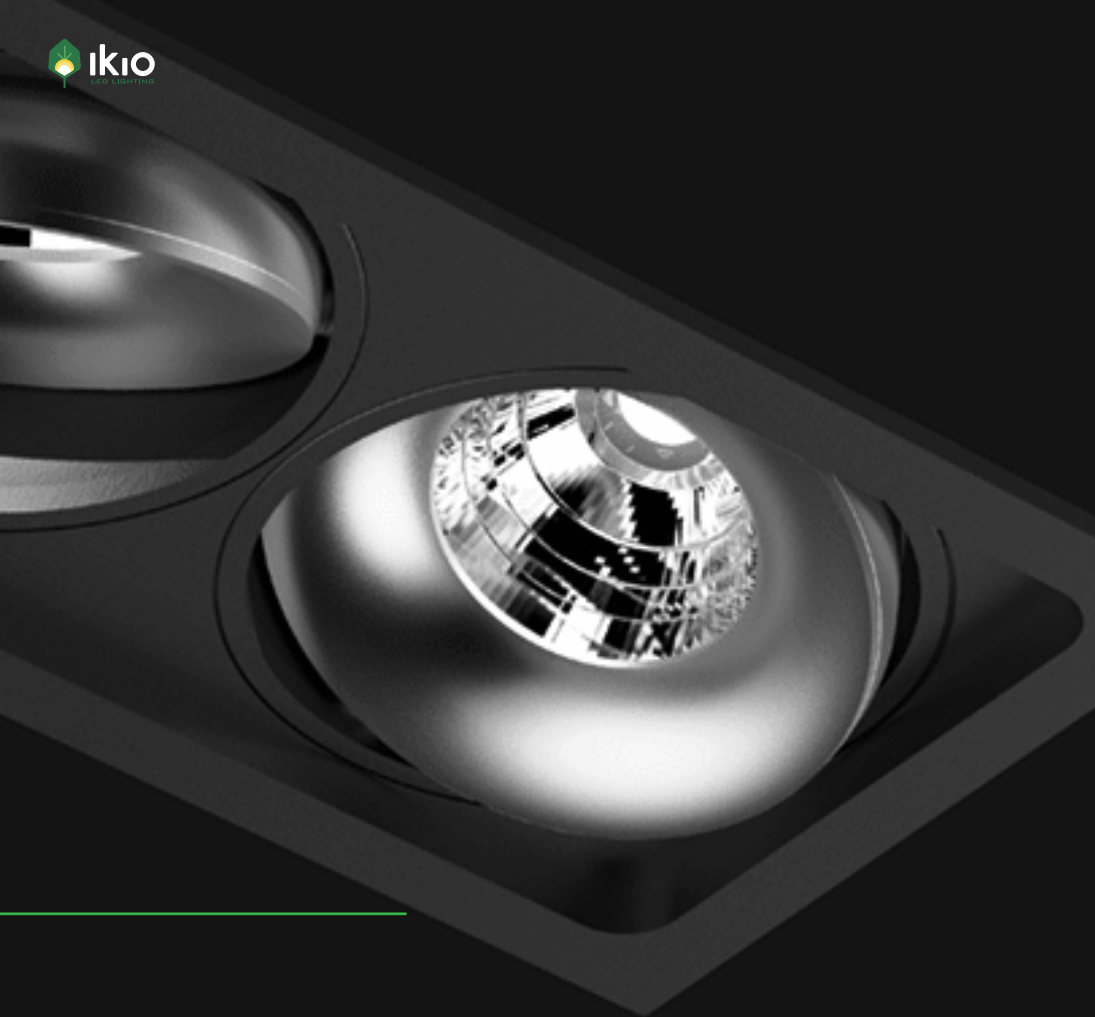

Lumos

Downlight

Circular in design, this LED downlight is made of aluminum die cast with high quality powder coated luminaire housing and optimum heat sink. Available in multiple wattages and beam angles, the luminaire renders greater flexibility in its application for store lighting. Moreover, the specular darklight reflector in this store light allows outstanding visual comfort to the visitors.

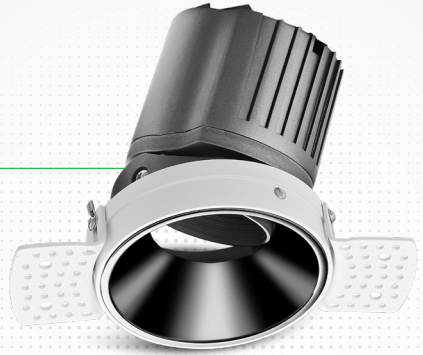

> Technical Parameters

Voltage	100 - 277 V AC, 50-60 Hz
Light Source	Osram SOLERIQ S 19
Operating Position	Non-Swiveling Type
Start Time	Instant
Driver	Stand Alone (Included)
Optics	Darklight Technology Black, Silver
Dimming	On-Off / Triac / 0-10 V

CRI	Power (W)	CCT (K)	Total Lumen Output (lm)	Finish
>90	8 / 15	2700	663 / 1230	Black / White
>90	8 / 15	3000	695 / 1291	Black / White
>90	8 / 15	3500	730 / 1356	Black / White
>90	8 / 15	4000	767 / 14237	Black / White

Note: Product available in other Kelvin temperatures on request.

> Model/Colors

Available in Black and White.



> Application Areas

Downlight for Indoor Applications.
Guest Room, Corridor, Restaurant,
Meeting Room, Club, Hall, Hotel Entrance



> Technical Drawing

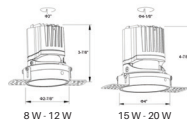

> Beam Spread (Options)

Spot		Medium		Flood		Wide Flood	
15°		24°		38°		60°	
ft	ø	ft	ø	ft	ø	ft	ø
3.0	0.72	3.0	1.41	3.0	2.03	3.0	3.15
9.0	2.15	9.0	4.22	9.0	6.09	9.0	9.45
15.0	3.58	15.0	7.04	15.0	10.15	15.0	15.75

Note: Product available in other Kelvin temperatures on request.

Theia

Downlight

Theia, a square LED downlight, is made of aluminum die cast with high-quality powder coated luminaire housing and optimum heat sink. Specular reflector & power grid /global connectors available with isolated LED Driver using Ultra bright OSRAM COB.

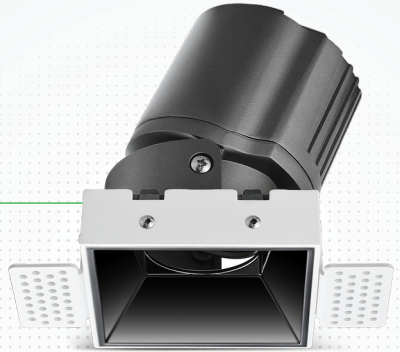

Technical Parameters

Voltage	100 - 277 V AC, 50-60 Hz
Light Source	Osram SOLERIQ S 19
Operating Position	Non-Swiveling Type
Start Time	Instant
Driver	Stand Alone (Included)
Optics	Darklight Technology Black, Silver
Dimming	On-Off / Triac / 0-10 V

CRI	Power (W)	CCT (K)	Total Lumen Output (lm)	Finish
>90	8 / 15	2700	663 / 1230	Black / White
>90	8 / 15	3000	695 / 1291	Black / White
>90	8 / 15	3500	730 / 1356	Black / White
>90	8 / 15	4000	767 / 14237	Black / White

Note: Product available in other Kelvin temperatures on request.

Model/Colors

Available in Black and White.



Application Areas

Downlight for Indoor Applications.
Guest Room, Corridor, Restaurant,
Meeting Room, Club, Hall, Hotel Entrance



Technical Drawing

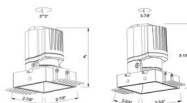

8 W - 12 W

15 W - 20 W

Beam Spread (Options)

Spot		Medium		Flood		Wide Flood	
15°		24°		38°		60°	
ft	ø	ft	ø	ft	ø	ft	ø
3.0	0.72	3.0	1.41	3.0	2.03	3.0	3.15
9.0	2.15	9.0	4.22	9.0	6.09	9.0	9.45
15.0	3.58	15.0	7.04	15.0	10.15	15.0	15.75

Note: Product available in other Kelvin temperatures on request.

Olivio

Downlight

Olivio is a round LED downlight made of aluminum die cast with high-quality powder coated luminaire housing and optimum heat sink. Specular reflector & power grid /global connectors available with isolated LED driver using ultra-bright OSRAM COB.

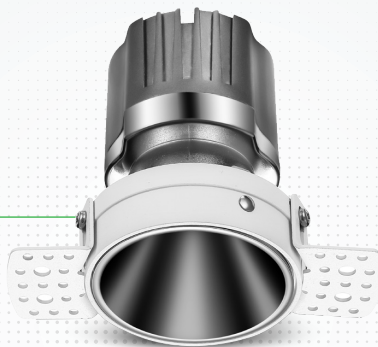

> Technical Parameters

Voltage	100 - 277 V AC, 50-60 Hz
Light Source	Osram SOLERIQ S 19
Operating Position	Non-Swiveling Type
Start Time	Instant
Driver	Stand Alone (Included)
Optics	Darklight Technology Black, Silver
Dimming	On-Off / Triac / 0-10 V

CRI	Power (W)	CCT (K)	Total Lumen Output (lm)	Finish
>90	8 / 15 / 25 / 30	2700	623 / 1230 / 2038 / 2442	Black / White
>90	8 / 15 / 25 / 30	3000	695 / 1291 / 2138 / 2564	Black / White
>90	8 / 15 / 25 / 30	3500	730 / 1356 / 2247 / 2692	Black / White
>90	8 / 15 / 25 / 30	4000	767 / 1423.43 / 2360 / 2827	Black / White

Note: Product available in other Kelvin temperatures on request.

> Model/Colors

Available in Black and White.



> Application Areas

Downlight for Indoor Applications.
Guest Room, Corridor, Restaurant,
Meeting Room, Club, Hall, Hotel Entrance



Note: Product available in other Kelvin temperatures on request.

> Technical Drawing

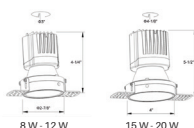

> Beam Spread (Options)

Spot	15°		Medium		24°		Flood		38°		Wide Flood		60°	
	ft	ø	ft	ø	ft	ø	ft	ø	ft	ø	ft	ø	ft	ø
3.0	0.72	3.0	1.41	3.0	2.03	3.0	3.15	3.0	3.15	3.0	3.15	3.0	3.15	3.0
9.0	2.15	9.0	4.22	9.0	6.09	9.0	9.45	9.0	9.45	9.0	9.45	9.0	9.45	9.0
15.0	3.58	15.0	7.04	15.0	10.15	15.0	15.75	15.0	15.75	15.0	15.75	15.0	15.75	15.0

Glint

Downlight

Glint, a circular-shaped LED downlight, is made of aluminum die cast with high-quality powder coated luminaire housing and optimum heat sink. Specular reflector & power grid / global connectors available with isolated LED Driver using ultra-bright OSRAM COB.

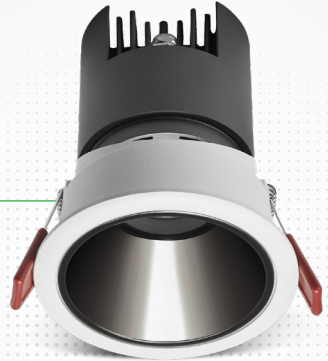

Technical Parameters

Voltage	100 - 277 V AC, 50-60 Hz
Light Source	Osram SOLERIQ S 19
Operating Position	Swiveling Type
Start Time	Instant
Driver	Stand Alone (Included)
Optics	Darklight Technology Black, Silver
Dimming	On-Off / Triac / 0-10 V

CRI	Power (W)	CCT (K)	Total Lumen Output (lm)	Finish
>90	8 / 15 / 20 / 30 / 40 / 50 / 55	2700	680 / 1275 / 1700 / 2550 / 3200 / 4000 / 4400	White
>90	8 / 15 / 20 / 30 / 40 / 50 / 55	3000	680 / 1275 / 1700 / 2550 / 3200 / 4000 / 4400	White
>90	8 / 15 / 20 / 30 / 40 / 50 / 55	3500	680 / 1275 / 1700 / 2550 / 3200 / 4000 / 4400	White
>90	8 / 15 / 20 / 30 / 40 / 50 / 55	4000	680 / 1275 / 1700 / 2550 / 3200 / 4000 / 4400	White

Note: Product available in other Kelvin temperatures on request.

Model/Colors

Available in White.



Application Areas

Downlight for Indoor Applications.
Guest Room, Corridor, Restaurant,
Meeting Room, Club, Hall, Hotel Entrance



Technical Drawing

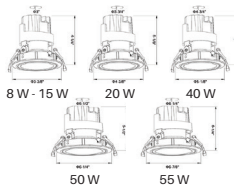

Beam Spread (Options)

Spot	15°		Medium	24°		Flood	38°	
	ft	ø		ft	ø		ft	ø
3.0	0.72	3.0	1.41	3.0	2.03	15.0	3.58	
9.0	2.15	9.0	4.22	9.0	6.09	15.0	7.04	
15.0	3.58	15.0	7.04	15.0	10.15	15.0	10.15	

Note: 1. Product available in other Kelvin temperatures on request.
2. Reflector Colour- Black, White, Silver, Golden available.

Ocul

Downlight

Ocul, a round-shaped LED downlight, is made of aluminum die cast with high-quality powder coated luminaire housing and optimum heat sink. Specular reflector & power grid / global connectors available with isolated LED Driver using ultra-bright OSRAM COB.



Technical Parameters

Voltage	100 - 277 V AC, 50-60 Hz
Light Source	Osram SOLERIQ S 19
Operating Position	Non - Swiveling Type
Start Time	Instant
Driver	Stand Alone (Included)
Optics	Darklight Technology Black, Silver
Dimming	On-Off / Triac / 0-10 V

CRI	Power (W)	CCT (K)	Total Lumen Output (lm)	Finish
>90	8 / 15 / 20 / 30 / 40 / 50	2700	1200 / 1800 / 2400 / 3600 / 4800 / 6000	White
>90	8 / 15 / 20 / 30 / 40 / 50	3000	1264 / 1895 / 2527 / 3790 / 5054 / 6318	White
>90	8 / 15 / 20 / 30 / 40 / 50	3500	1330 / 2000 / 2660 / 3990 / 5320 / 6650	White
>90	8 / 15 / 20 / 30 / 40 / 50	4000	1400 / 2100 / 2800 / 4200 / 5600 / 7000	White

Note: Product available in other Kelvin temperatures on request.

Model/Colors

Available in White.



Application Areas

Downlight for Indoor Applications.
Classroom, Meeting Room,
Office, Club, Home.



Technical Drawing

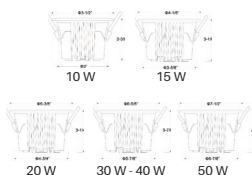

Beam Spread (Options)

Spot	15°		24°		36°		Wide Flood 60°	
	ft	o	ft	o	ft	o	ft	o
30	0.72	30	1.41	30	2.03	30	3.15	
90	2.15	90	4.22	90	6.09	90	9.45	
150	3.58	150	7.04	150	10.15	150	15.75	

Note: 1. Product available in other Kelvin temperatures on request.

2. Reflector Colour- Black, White, Silver, Golden available. 3. SMD can improve lumen efficiency to 120-130 lm/W by adding extra cost.

Nova

Downlight

Nova, a round-shaped LED downlight, is made of aluminum die cast with high-quality powder coated luminaire housing and optimum heat sink. The specular darklight reflector in this store light allows outstanding visual comfort to the visitors so that they are able to explore the merchandise at ease.



Technical Parameters

Voltage	100 - 277 V AC, 50-60 Hz
Light Source	Osram SOLERIQ S 19
Operating Position	Swiveling Type, 360D
Start Time	Instant
Driver	Stand Alone (Included)
Optics	Darklight Technology Black, Silver
Dimming	On-Off / Triac / 0-10 V

CRI	Power (W)	CCT (K)	Total Lumen Output (lm)	Finish
>90	12 / 20 / 30	2700	1080 / 1600 / 2700	White
>90	12 / 20 / 30	3000	1080 / 1600 / 2700	White
>90	12 / 20 / 30	4000	1080 / 1600 / 2700	White
>90	12 / 20 / 30	5000	1080 / 1600 / 2700	White

Note: Product available in other Kelvin temperatures on request.

Model/Colors

Available in White.



Application Areas

Downlight for Indoor Applications.
Guest Room, Corridor, Restaurant,
Meeting Room, Club, Hall, Hotel Entrance



Technical Drawing

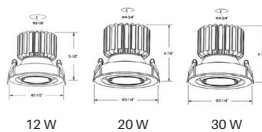

Beam Spread (Options)

Spot	15°	Medium	24°	Flood	36°
ft	0	3.0	3.0	3.0	3.0
ft	0.72	1.41	1.41	2.03	2.03
9.0	2.15	4.22	4.22	6.09	6.09
15.0	3.58	7.04	7.04	10.15	10.15

Note: 1. Product available in other Kelvin temperatures on request.

2. Black/White inner ring -IP44 type available, at added extra cost. 3. 30 W has Energy star type option, at added extra cost.

Scint

Downlight

Square in design, Scint LED downlight is made of aluminum die cast with high-quality powder coated luminaire housing and optimum heat sink. Available in multiple wattages and beam angles, the luminaire renders greater flexibility in its application for store lighting. Moreover, the specular darklight reflector in this store light allows outstanding visual comfort to the visitors.



› Technical Parameters

Voltage	100 - 277 V AC, 50-60 Hz
Light Source	Osram SOLERIQ S 19
Operating Position	Swiveling Type, 360D
Start Time	Instant
Driver	Stand Alone (Included)
Optics	Darklight Technology Black, Silver
Dimming	On-Off / Triac / 0-10 V

CRI	Power (W)	CCT (K)	Total Lumen Output (lm)	Finish
>90	12 / 20 / 30	2700	1080 / 1800 / 2700	White
>90	12 / 20 / 30	3000	1080 / 1800 / 2700	White
>90	12 / 20 / 30	3500	1080 / 1800 / 2700	White
>90	12 / 20 / 30	4000	1080 / 1800 / 2700	White

Note: Product available in other Kelvin temperatures on request.

› Model/Colors

Available in White.



› Application Areas

Downlight for Indoor Applications.
Guest Room, Corridor, Restaurant,
Meeting Room, Club, Hall, Hotel Entrance



› Technical Drawing

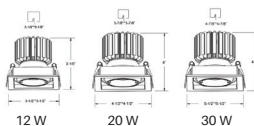

› Beam Spread (Options)

Spot	15°	Medium	24°	Flood	38°
ft	0	ft	0	ft	0
3.0	0.72	3.0	1.41	3.0	2.03
9.0	2.15	9.0	4.22	9.0	6.09
15.0	3.58	15.0	7.04	15.0	10.15

Note: Product available in other Kelvin temperatures on request.

Odin

Downlight

Create the desired lighting effect in your stores with IKIO's Odin, a twin square LED downlight made of aluminum die cast with high-quality powder coated luminaire housing and optimum heat sink. These properties of the luminaire contribute to its effective functioning for a longer time period. Moreover, available in multiple wattages, color temperatures, finishes, and beam angles, this luminaire offers greater flexibility in its application.



› Technical Parameters

Voltage	100 - 277 V AC, 50-60 Hz
Light Source	Osram SOLERIQ S 19
Operating Position	Swiveling Type, 360D
Start Time	Instant
Driver	Stand Alone (Included)
Optics	Darklight Technology Black, Silver
Dimming	On-Off / Triac / 0-10 V

CRI	Power (W)	CCT (K)	Total Lumen Output (lm)	Finish
>90	20 / 30 / 55	2700	2880 / 4800 / 7200	White
>90	20 / 30 / 55	3000	3030 / 5050 / 7580	White
>90	20 / 30 / 55	3500	3190 / 5320 / 7980	White
>90	20 / 30 / 55	4000	3360 / 5600 / 8400	White

Note: Product available in other Kelvin temperatures on request.

› Model/Colors

Available in White.



› Application Areas

Downlight for Indoor Applications.
Guest Room, Corridor, Restaurant,
Meeting Room, Club, Hall, Hotel Entrance



› Technical Drawing

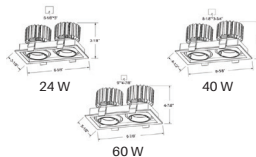

› Beam Spread (Options)

Spot	15°		24°		36°	
	ft	ø	ft	ø	ft	ø
3.0	0.72	3.0	1.41	3.0	2.03	
9.0	2.15	9.0	4.22	9.0	6.09	
15.0	3.58	15.0	7.04	15.0	10.15	

Note: Product available in other Kelvin temperatures on request.

Glim

Downlight

Glim, a round-shaped LED downlight, is made of aluminum die cast with high-quality powder coated luminaire housing and optimum heat sink. Specular reflector & power grid/global connectors available with isolated LED driver using ultra-bright OSRAM COB.



› Technical Parameters

Voltage	100 - 277 V AC, 50-60 Hz
Light source	Osram SOLERIQ S 19
Operating Position	Non - Swiveling Type
Start time	Instant
Driver	Stand Alone (Included)
Optics	Darklight Technology Black, Silver
Dimming	On-Off / Triac / 0-10 V

CRI	Power (W)	CCT (K)	Total Lumen Output (lm)	Finish
>90	12 / 15 / 20 / 30 / 40	2700	1080 / 1350 / 1800 / 2700 / 3600	Black / White
>90	12 / 15 / 20 / 30 / 40	3000	1080 / 1350 / 1800 / 2700 / 3600	Black / White
>90	12 / 15 / 20 / 30 / 40	3500	1080 / 1350 / 1800 / 2700 / 3600	Black / White
>90	12 / 15 / 20 / 30 / 40	4000	1080 / 1350 / 1800 / 2700 / 3600	Black / White

Note: Product available in other Kelvin temperatures on request.

› Model/Colors

Available in Black and White.



› Application Areas

Downlight for Indoor Applications.
Outdoor Corridor, Bathroom, Eave.



Note: Product available in other Kelvin temperatures on request.

› Technical Drawing

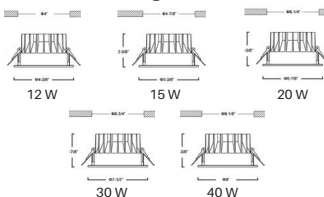

› Beam Spread (Options)

Wide Flood		60°
ft	ø	
3.0	3.15	
9.0	9.45	
15.0	15.75	

Flare

Downlight

Flare downlight is a square-shaped fixture that illuminates a store in the most effective manner without being obtrusive. The smart engineering of the luminaire with specular reflector & power grid/ global connectors, along with a high voltage standing in-house LED driver, makes it an ideal choice for lighting your stores.



> Technical Parameters

Voltage	100 - 277 V AC, 50-60 Hz
Light Source	Osram SOLERIQ S 19
Operating Position	Non - Swiveling Type
Start Time	Instant
Driver	Stand Alone (Included)
Optics	Darklight Technology Black, Silver
Dimming	On-Off / Triac / 0-10 V

CRI	Power (W)	CCT (K)	Total Lumen Output (lm)	Finish
>90	12 / 15 / 20 / 30 / 40	2700	1080 / 1350 / 1800 / 2700 / 3600	White / Black
>90	12 / 15 / 20 / 30 / 40	3000	1080 / 1350 / 1800 / 2700 / 3600	White / Black
>90	12 / 15 / 20 / 30 / 40	3500	1080 / 1350 / 1800 / 2700 / 3600	White / Black
>90	12 / 15 / 20 / 30 / 40	4000	1080 / 1350 / 1800 / 2700 / 3600	White / Black

Note: Product available in other Kelvin temperatures on request.

> Model/Colors

Available in Black and White.



> Application Areas

Downlight for Indoor Applications.
Outdoor Corridor, Bathroom, Eave.



> Technical Drawing

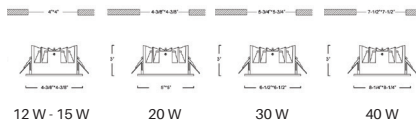

> Beam Spread (Options)

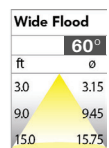

Note: Product available in other Kelvin temperatures on request.

Gleam

Downlight

Gleam, a square-shaped LED downlight, is made of aluminum die cast with high-quality powder coated luminaire housing and optimum heat sink that ensure high-durability. The specular darklight reflector in this store light allows outstanding visual comfort to the visitors so that they are able to explore the merchandise with ease.



► Technical Parameters

Voltage	100 - 277 V AC, 50-60 Hz
Light Source	Osram SOLERIQ S 19
Operating Position	Swiveling Type
Start Time	Instant
Driver	Stand Alone (Included)
Optics	Darklight Technology Black, Silver
Dimming	On-Off / Triac / 0-10 V

CRI	Power (W)	CCT (K)	Total Lumen Output (lm)	Finish
>90	8 / 15	2700	663 / 1230	Black / White
>90	8 / 15	3000	695 / 1291	Black / White
>90	8 / 15	3500	730 / 1356	Black / White
>90	8 / 15	4000	767 / 1424	Black / White

Note: Product available in other Kelvin temperatures on request.

► Model/Colors

Available in Black and White.



► Application Areas

Downlight for Indoor Applications.
Guest Room, Corridor, Restaurant,
Meeting Room, Club, Hall, Hotel Entrance



► Technical Drawing

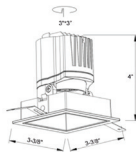

► Beam Spread (Options)

Spot		Medium		Flood		Wide Flood	
ft	ø	ft	ø	ft	ø	ft	ø
3.0	0.72	3.0	1.41	3.0	2.03	3.0	3.15
9.0	2.15	9.0	4.22	9.0	6.09	9.0	9.45
15.0	3.58	15.0	7.04	15.0	10.15	15.0	15.75

Note: Product available in other Kelvin temperatures on request.

Aspro

Downlight

Aspro, a square LED downlight, is made of aluminum die cast with high-quality powder coated luminaire housing and optimum heat sink. Specular reflector & power grid /global connectors available with isolated LED driver using ultra-bright OSRAM COB. Moreover, the specular darklight reflector in this store light allows outstanding visual comfort to the visitors.



› Technical Parameters

Voltage	100 - 277 V AC, 50-60 Hz
Light Source	Osram SOLERIQ S 19
Operating Position	Non - Swiveling Type
Start Time	Instant
Driver	Stand Alone (Included)
Optics	Darklight Technology Black, Silver
Dimming	On-Off / Triac / 0-10 V

CRI	Power (W)	CCT (K)	Total Lumen Output (lm)	Finish
>90	12 / 20 / 30 / 40 / 50	2700	1440 / 2400 / 3600 / 4800 / 6000	White / Black
>90	12 / 20 / 30 / 40 / 50	3000	1516 / 2520 / 3790 / 5050 / 6300	White / Black
>90	12 / 20 / 30 / 40 / 50	4000	1600 / 2660 / 4000 / 5320 / 6650	White / Black
>90	12 / 20 / 30 / 40 / 50	5000	1680 / 2800 / 4200 / 5600 / 7000	White / Black

› Model/Colors

Available in Black and White.



› Application Areas

Downlight for Indoor Applications.
Guest Room, Corridor, Restaurant,
Meeting Room, Club, Hall, Hotel Entrance.



› Technical Drawing

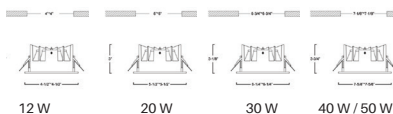



› Beam Spread (Options)

Wide Flood		50°
ft	ø	
3.0	3.15	
9.0	9.45	
15.0	15.75	

Note: Product available in other Kelvin temperatures on request.

Pendant Lights

Pendant lights are commonly used in stores as ambient or task lights. They are a perfect replacement for traditional store lights and deliver both both style and function. Pendant lights can be used in places such as the bill counter, aisle areas, or changing rooms within a store.

-  Come in varied shapes and sizes to complement different spaces.
-  Their unique designs uplift the aesthetic appeal of your stores.
-  Are highly customizable, low maintenance, and flexible.



Remus

Pendant Light

Remus is a technologically advanced LED pendant light that incorporates electronic gear and a high-quality lens with three different beam spreads. While commonly used as a task light, the unique and state-of-the-art design of this luminaire also enhances the overall aesthetics of your store.



> Technical Parameters

Voltage	100 - 277 V AC, 50-60 Hz
Light Source	Osram SOLERIQ S 19
Operating Position	Swiveling Type
Start Time	Instant
Driver	Stand Alone (Included)
Beam Spread	Spot, Medium, Flood
Dimming	Triac Dimming

CRI	Power (W)	CCT (K)	Total Lumen Output (lm)	Finish
>90	20	2700	1800	Black / White
>90	20	3000	1900	Black / White
>90	20	4000	2000	Black / White
>90	20	5000	2100	Black / White

> Model/Colors

Available in White & Black.



> Application Areas

Pendant Light for Indoor Applications.



> Technical Drawing



> Beam Spread (Options)

Spot		Medium		Flood	
11°		24°		36°	
ft	ø	ft	ø	ft	ø
3.0	0.72	3.0	1.41	3.0	2.03
9.0	2.15	9.0	4.22	9.0	6.09
15.0	3.58	15.0	7.04	15.0	10.15

Note: 1. Product available in other Kelvin temperatures on request.

2. Ceiling cup standard size: 4-3/4". 3. Cable standard length: 2'.

Aurora

Pendant Light

Aurora is a technologically advanced LED pendant light that incorporates electronic gear and a high-quality lens with a wide beam spread. While commonly used as a task light, the unique and state-of-the-art design of this luminaire also enhances the overall aesthetics of your store.

> Technical Parameters

Voltage	100 - 277 V AC, 50-60 Hz
Light Source	Osram SOLERIQ S 19
Operating Position	No Swiveling Type
Start Time	Instant
Driver	Stand Alone (Included)
Optics	Reflective Cup Structure
Beam Spread	Spot, Medium, Flood
Dimming	Triac Dimming / 0-10 V Dimming

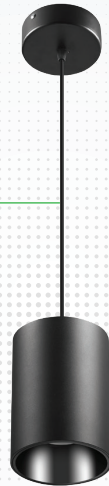

CRI	Power (W)	CCT (K)	Total Lumen Output (lm)	Finish
>90	8 / 12 / 15 / 20 / 25 / 30 / 40 / 50 / 55	2700	640 / 960 / 1200 / 1600 / 2000 / 2400 / 3200 / 4000 / 4400	Black / White
>90	8 / 12 / 15 / 20 / 25 / 30 / 40 / 50 / 55	3000	680 / 1020 / 1275 / 1700 / 2125 / 2550 / 3400 / 4250 / 4675	Black / White
>90	8 / 12 / 15 / 20 / 25 / 30 / 40 / 50 / 55	4000	720 / 1080 / 1350 / 1800 / 2250 / 2700 / 3600 / 4500 / 4950	Black / White
>90	8 / 12 / 15 / 20 / 25 / 30 / 40 / 50 / 55	5000	760 / 1140 / 1425 / 1900 / 2375 / 2850 / 3800 / 4750 / 5225	Black / White

> Model/Colors

Available in White & Black.



> Application Areas

Pendant Light for Indoor Applications.
Guest Room, Restaurant, Meeting Room,
Club, Hall, Hotel Entrance



> Technical Drawing

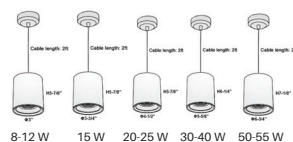

> Beam Spread (Options)

Spot		Medium		Flood	
15°		30°		45°	
ft	Ø	ft	Ø	ft	Ø
3.0	0.72	3.0	1.41	3.0	2.03
9.0	2.15	9.0	4.22	9.0	6.09
15.0	3.58	15.0	7.04	15.0	10.15

Note: 1. Product available in other Kelvin temperatures on request.

2. Reflector color: Black/White/Silver option available. 3. Ceiling cup standard size: 4-3/4"; Cable standard length: 2'.

Eos

Pendant Light



Eos is a technologically advanced LED pendant light that incorporates electronic gear and a high-quality lens with three different beam spreads. While commonly used as a task light, the unique and state-of-the-art design of this luminaire also enhances the overall aesthetics of your store.

> Technical Parameters

Voltage	100 - 277 V AC, 50-60 Hz
Light Source	Osram SOLERIQ S 19
Operating Position	No Swiveling Type
Start Time	Instant
Driver	Stand Alone (Included)
Optics	Reflective Cup Structure
Beam Spread	Spot, Medium, Flood
Dimming	Triac Dimming / 0-10 V Dimming

CRI	Power (W)	CCT (K)	Total Lumen Output (lm)	Finish
>90	8 / 15 / 20 / 30	2700	640 / 1200 / 1600 / 2400	Black / White
>90	8 / 15 / 20 / 30	3000	680 / 1275 / 1700 / 2550	Black / White
>90	8 / 15 / 20 / 30	4000	720 / 1350 / 1800 / 2700	Black / White
>90	8 / 15 / 20 / 30	5000	760 / 1425 / 1900 / 2850	Black / White

> Model/Colors

Available in White & Black.



> Application Areas

Pendant Light for Indoor Applications.
Guest Room, Restaurant, Meeting Room,
Club, Hall, Hotel Entrance



> Technical Drawing

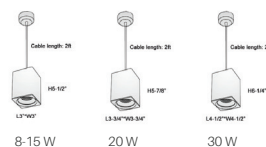

> Beam Spread (Options)

Spot		Medium		Flood	
15°		30°		45°	
ft	Ø	ft	Ø	ft	Ø
3.0	0.72	3.0	1.41	3.0	2.03
9.0	2.15	9.0	4.22	9.0	6.09
15.0	3.58	15.0	7.04	15.0	10.15

Note: Product available in other Kelvin temperatures on request.

Mica

Pendant Light

Mica is a technologically advanced LED pendant light that incorporates electronic gear and a high-quality lens with wide beam spread. While commonly used as a task light, the unique and state-of-the-art design of this luminaire also enhances the overall aesthetics of your store.

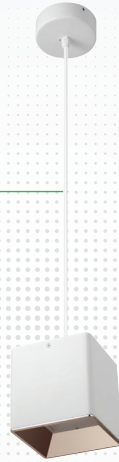

› Technical Parameters

Voltage	100 - 277 V AC, 50-60 Hz
Light Source	Osram SOLERIQ S 19
Operating Position	No Swiveling Type
Start Time	Instant
Driver	Stand Alone (Included)
Optics	Reflective Cup Structure
Beam Spread	Spot, Medium, Flood
Dimming	Triac Dimming / 0-10 V Dimming

CRI	Power (W)	CCT (K)	Total Lumen Output (lm)	Finish
>90	8 / 15 / 20 / 30 / 40	2700	640 / 1200 / 1600 / 2400 / 3200	White
>90	8 / 15 / 20 / 30 / 40	3000	680 / 1275 / 1700 / 2550 / 3400	White
>90	8 / 15 / 20 / 30 / 40	4000	720 / 1350 / 1800 / 2700 / 3600	White
>90	8 / 15 / 20 / 30 / 40	5000	760 / 1425 / 1900 / 2850 / 3800	White

› Model/Colors

Available in White.



› Application Areas

Pendant Light for Indoor Applications.
Guest Room, Restaurant, Meeting Room,
Club, Hall, Hotel Entrance



› Technical Drawing

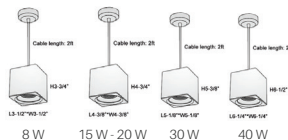

› Beam Spread (Options)

Spot	Medium	Flood
ft	0	0
3.0	0.72	2.03
9.0	2.15	6.09
15.0	3.58	10.15

Note: 1. Product available in other Kelvin temperatures on request.
2. Ceiling cup standard size: 4-3/4"; Cable standard length: 2'.

Flaxo

Pendant Light

Flaxo is a technologically advanced LED pendant light that incorporates electronic gear and a high-quality lens with a wide beam spread. While commonly used as a task light, the unique and state-of-the-art design of this luminaire also enhances the overall aesthetics of your store.

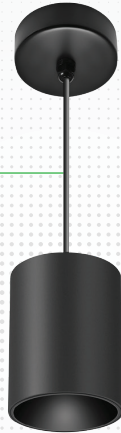

> Technical Parameters

Voltage	100 - 277 V AC, 50-60 Hz
IP Rating	IP65
Light Source	Osram SOLERIQ S 19
Operating Position	No Swiveling Type
Start Time	Instant
Driver	Stand Alone (Included)
Optics	Reflective Cup Structure
Beam Spread	Medium, Flood
Dimming	Triac Dimming / 0-10 V Dimming

CRI	Power (W)	CCT (K)	Total Lumen Output (lm)	Finish
>90	8 / 15 / 20 / 30 / 40 / 50 / 55	2700	640 / 1200 / 1800 / 2400 / 3200 / 4000 / 4400	Black / White
>90	8 / 15 / 20 / 30 / 40 / 50 / 55	3000	680 / 1275 / 1700 / 2550 / 3400 / 4250 / 4675	Black / White
>90	8 / 15 / 20 / 30 / 40 / 50 / 55	4000	720 / 1350 / 1800 / 2700 / 3600 / 4500 / 4950	Black / White
>90	8 / 15 / 20 / 30 / 40 / 50 / 55	5000	760 / 1425 / 1900 / 2850 / 3800 / 4750 / 5225	Black / White

> Model/Colors

Available in White & Black.



> Application Areas

Pendant Light for Indoor Applications.
Guest Room, Restaurant, Meeting Room,
Club, Hall, Hotel Entrance



> Technical Drawing

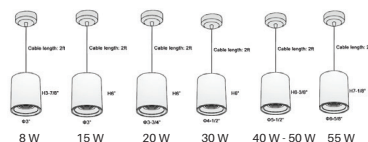



> Beam Spread (Options)



Medium		Flood	
20°		40°	
ft	Ø	ft	Ø
3.0	1.41	3.0	2.03
9.0	4.22	9.0	6.09
15.0	7.04	15.0	10.15

Note: Product available in other Kelvin temperatures on request.



Cross Reference Guide

Track Lights



IKIO		Other Brand
<p>Amplic Track Light</p> 		
Wattage	20W	20W
Lumen Output	1900lm	1200lm

IKIO		Other Brand
<p>Omate Track Light</p> 		
Wattage	30W	30W
Lumen Output	2450lm	1600lm

IKIO		Other Brand
<p>Optik Track Light</p> 		
Wattage	15W / 20W	20W
Lumen Output	2100lm / 3150lm	1500lm

IKIO		Other Brand
<p>Rimin Projector Light</p> 		
Wattage	20W / 30W	30W
Lumen Output	1900lm / 2850lm	1700lm

IKIO		Other Brand
<p>Trang Track Light</p> 		
Wattage	15W / 20W / 30W	25W
Lumen Output	1350lm / 1800lm / 2700lm	1200lm



IKIO		Other Brand
<p>Prime Track Light</p> 		
Wattage	20W	20W
Lumen Output	2000lm	1400lm

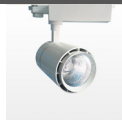

IKIO		Other Brand
<p>Bolide Track Light</p> 		
Wattage	30W	25W
Lumen Output	3150lm	1200lm

IKIO		Other Brand
<p>Avis Track Light</p> 		
Wattage	28W / 36W	36W
Lumen Output	2996lm / 3852lm	1800lm



Cross Reference Guide

Down Lights



IKIO		Other Brand
<p>Lucent Downlight</p>  		
Wattage	25W / 28W / 30W	30W
Lumen Output	2500lm / 2800lm / 3200lm	2500lm



IKIO		Other Brand
<p>Scrawn Downlight</p>  		
Wattage	25W / 30W	30W
Lumen Output	4600lm / 5520lm	3000lm



IKIO		Other Brand
<p>Glim Downlight</p>  		
Wattage	30W / 40W / 50W	50W
Lumen Output	3150lm / 4200lm / 5250lm	3500lm

IKIO		Other Brand
<p>Lumos Downlight</p>  		
Wattage	12W / 15W / 20W	20W
Lumen Output	1080lm / 1350lm / 1800lm	1400lm

IKIO		Other Brand
<p>Odin Downlight</p>  		
Wattage	24W / 40W / 60W	40W
Lumen Output	2160lm / 3600lm / 5400lm	3000lm

IKIO		Other Brand
<p>Pistone Downlight</p>  		
Wattage	40W / 50W / 55W	50W
Lumen Output	3800lm / 4750lm / 5225lm	3000lm

IKIO		Other Brand
<p>Avant Downlight</p>  		
Wattage	8W / 15W / 25W	25W
Lumen Output	840lm / 1575lm / 2625lm	1500lm

IKIO		Other Brand
<p>Cubra Downlight</p>  		
Wattage	20W / 30W	30W
Lumen Output	1900lm / 2850lm	2000lm

Know More About IKIO

IKIO is one of the fastest-growing LED brands in America with a successful track record of being a reliable and trusted lighting partner. IKIO combines innovative ideas, expertise & advanced technology to create cutting-edge lighting solutions that are changing the landscape of the lighting industry. We are ideally positioned to offer the right solutions for all your lighting requirements because of our holistic approach and vertically integrated infrastructure.

1



America's **top 500 fastest-growing companies** as per Inc 5000.

2



Headquartered in Indianapolis, Indiana: a strategic location that enables us to serve customers nationwide.

3



An expansive DLC-qualified **products**.

4



Serving **Commercial, Industrial, Hazardous Locations, as well as Horticulture Applications**.

5



6 World-class vertically-integrated manufacturing facilities in different countries.

6



Existing clients — H&M, Adidas, Hilton, Reebok, etc.



Store
Lights

A green circular graphic element consisting of a solid green circle and a thin green outline that overlaps it, positioned to the right of the text.



(1) 844-533-4546 | www.retail.ikioledlighting.com
8470 Allison Pointe Blvd, Suite 128 Indianapolis, IN 46250